

# QT Flow Sensor

## Installation & Commissioning Instructions

LV311424 | June 2014



**Read this manual carefully****Warning**

Read this manual carefully before starting the water heater and solar pump. Failure to read the manual and to follow the printed instructions may lead to personal injury and damage to the water heater and/or QT flow sensor.

**Copyright © 2014**

All rights reserved.

Nothing from this publication may be copied, reproduced and/or published by means of printing, photocopying or by whatsoever means, without the prior written approval of the supplier.

The supplier reserves the right to modify specifications stated in this manual.

**Trademarks**

Any brand names mentioned in this manual are registered trademarks of their respective owners.

**Liability**

The supplier accepts no liability for claims from third parties arising from unauthorised use, use other than that stated in this manual, and use other than in accordance with the General Conditions registered at the Chamber of Commerce.

Refer further to the General Conditions. These are available on request, free of charge.

Although considerable care has been taken to ensure a correct and suitably comprehensive description of all relevant components, the manual may nonetheless contain errors and inaccuracies. Should you detect any errors or inaccuracies in the manual, we would be grateful if you would inform us. This helps us to further improve our documentation.

**More information**

If you have any comments or queries concerning specific aspects related to the water heater and/or solar pump station, then please do not hesitate to contact :

Lochinvar Ltd.  
7 Lombard Way  
The MXL Centre  
Banbury  
Oxon  
OX16 4TJ

Tel: +44 (0) 1295 269 981  
Fax: +44 (0) 1295 271 640  
E-mail: [info@lochinvar.ltd.uk](mailto:info@lochinvar.ltd.uk)  
Website: [www.lochinvar.ltd.uk](http://www.lochinvar.ltd.uk)

In the event of problems with your electricity or other connections, please contact the supplier/installation engineer of your installation.

**Introduction**

These instructions describe the installation and commissioning of the QT flow sensor. The QT flow sensor measures the solar contribution of the solar system and displays this information on the display of the water heater (or remote display if applicable).

This chapter covers the following topics:

- Connecting the QT flow sensor hydraulically;
- Connecting the QT flow sensor to the control.

**Hydraulic connections**

**Warning**

The installation should be carried out by a competent person, in compliance with general and locally applicable regulations.

In order to make the hydraulic connections the following 6 rules, for installation, must be met:

**1. Position of the QT flow sensor in the flow**

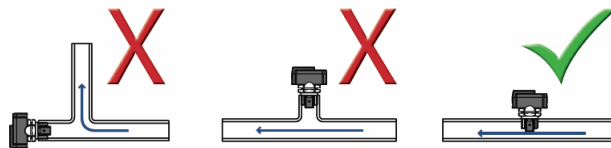

**2. Select a matching pipe diameter**

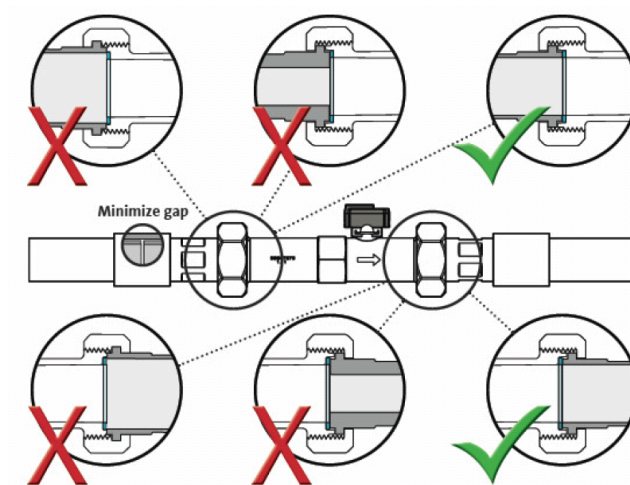

**3. Minimum distance to bends**

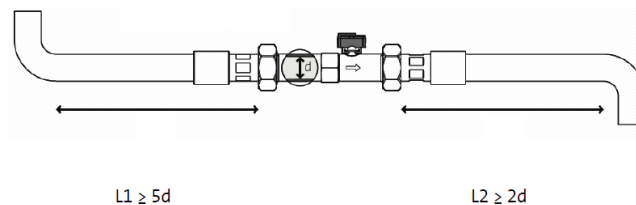

**4. Minimum distance to pump**

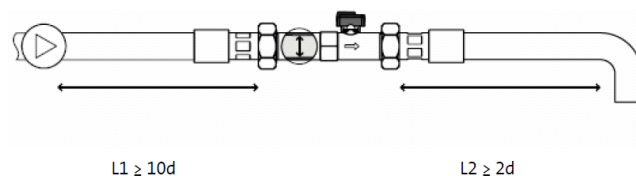

### 5. Minimum distance to valve

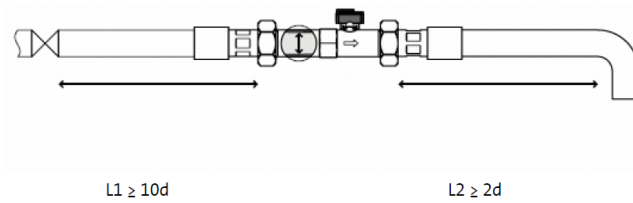

### 6. Minimum distance to T-connector

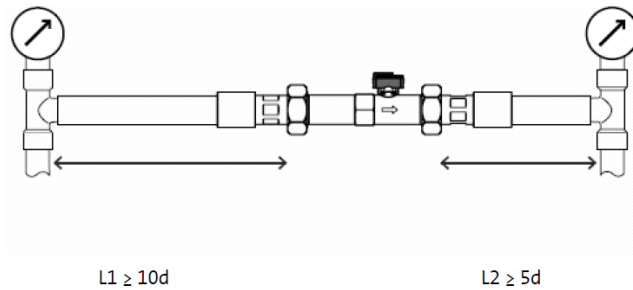

### Connection to control

#### Warning

The installation should be carried out by a competent person, in compliance with general and locally applicable regulations.

The QT flow sensor must be connected to the solar control of the HWHC or HWH. Remove the cover (snap-on type) from the terminal block of the control. Under the cover is a connection diagram.

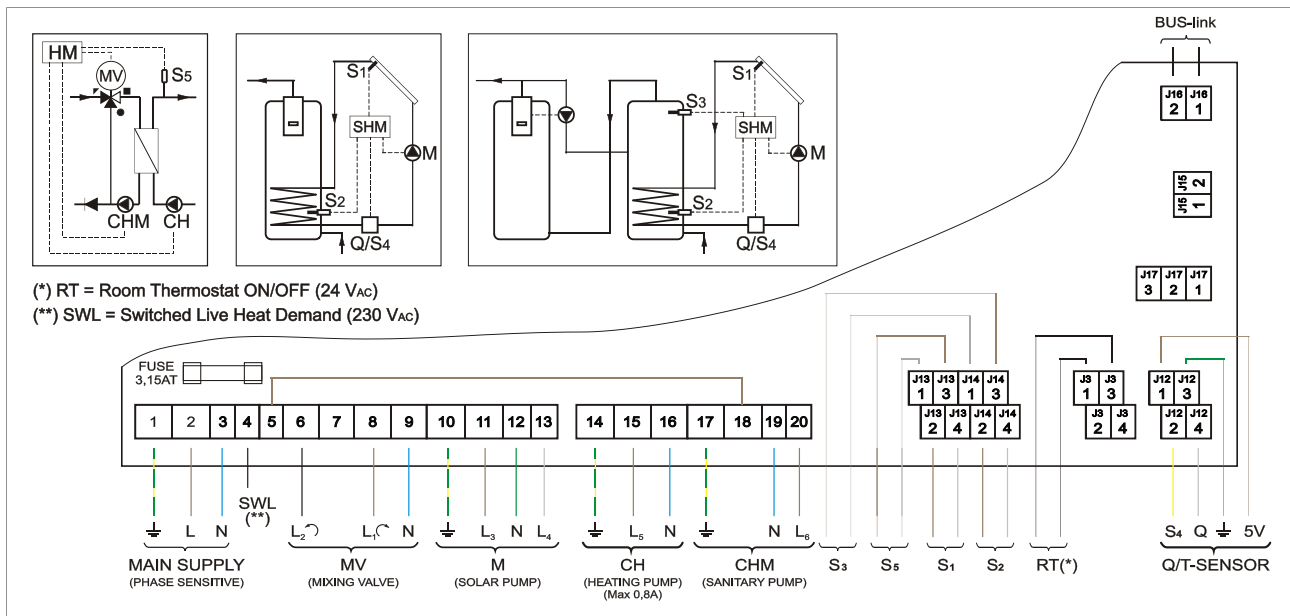

#### Note

The QT flow sensor is supplied with a connected cable.

You must connect this cable to the solar control.

Terminal	Type	Colour	Description	
J12	1	5V Live	brown	Live output to QT flow sensor.
	2	Temp-sensor	yellow	Temperature sensor of QT flow sensor.
	3	Earth	green	Earth QT flow sensor.
	4	Flow-sensor	bleu	Flow sensor of the QT flow sensor.

**Important**

See page 7 for the positions of the QT flow sensor cable.

*Connecting sensor to control*

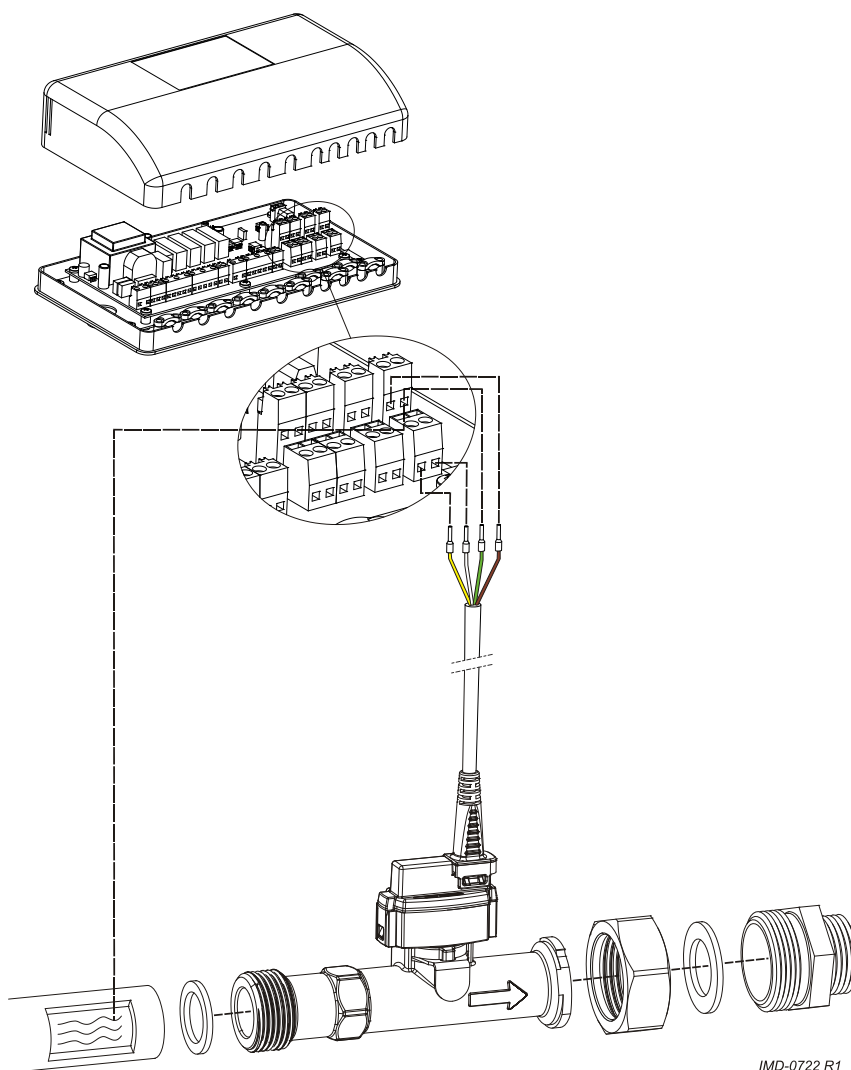



**Settings control**

To get the QT flow sensor to function, this functionality must be activated in the control of the water heater. This functionality must be activated by the following procedure:

1. Switch on the power supply to the water heater by using the isolator between the water heater and the power supply.
2. Switch the controller, of the water heater, **ON** by setting the ON/OFF-switch to **position I**.

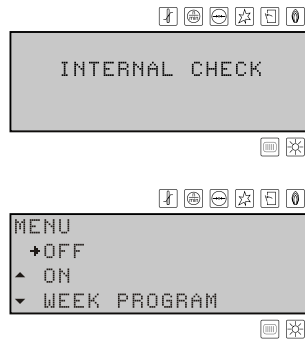
The display will now show INTERNAL CHECK for 10 seconds, and will then go to the main menu.



4. Press  once to bring up the service program. The display, as shown in the figure, will appear.



5. Press on the blue arrow () to position the cursor beside SOLAR CONFIG., then press ENTER. The display, as shown in the figure, will appear.

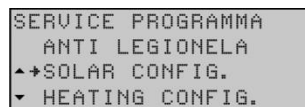

6. Confirm the selection Q/T-SENSOR with ENTER. The display, as shown in the figure, will appear.

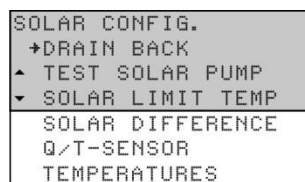

7. Press once on the red arrow () to position the cursor beside YES, then press ENTER.



By pressing ENTER the QT flow sensor functionality will become active and the system can be commissioned.

The following rules, regarding electrical resistance between sensor and earth and the separation of cables with "high" and "low" voltage, must be met in order to guarantee a the proper function of the QT flow sensor.

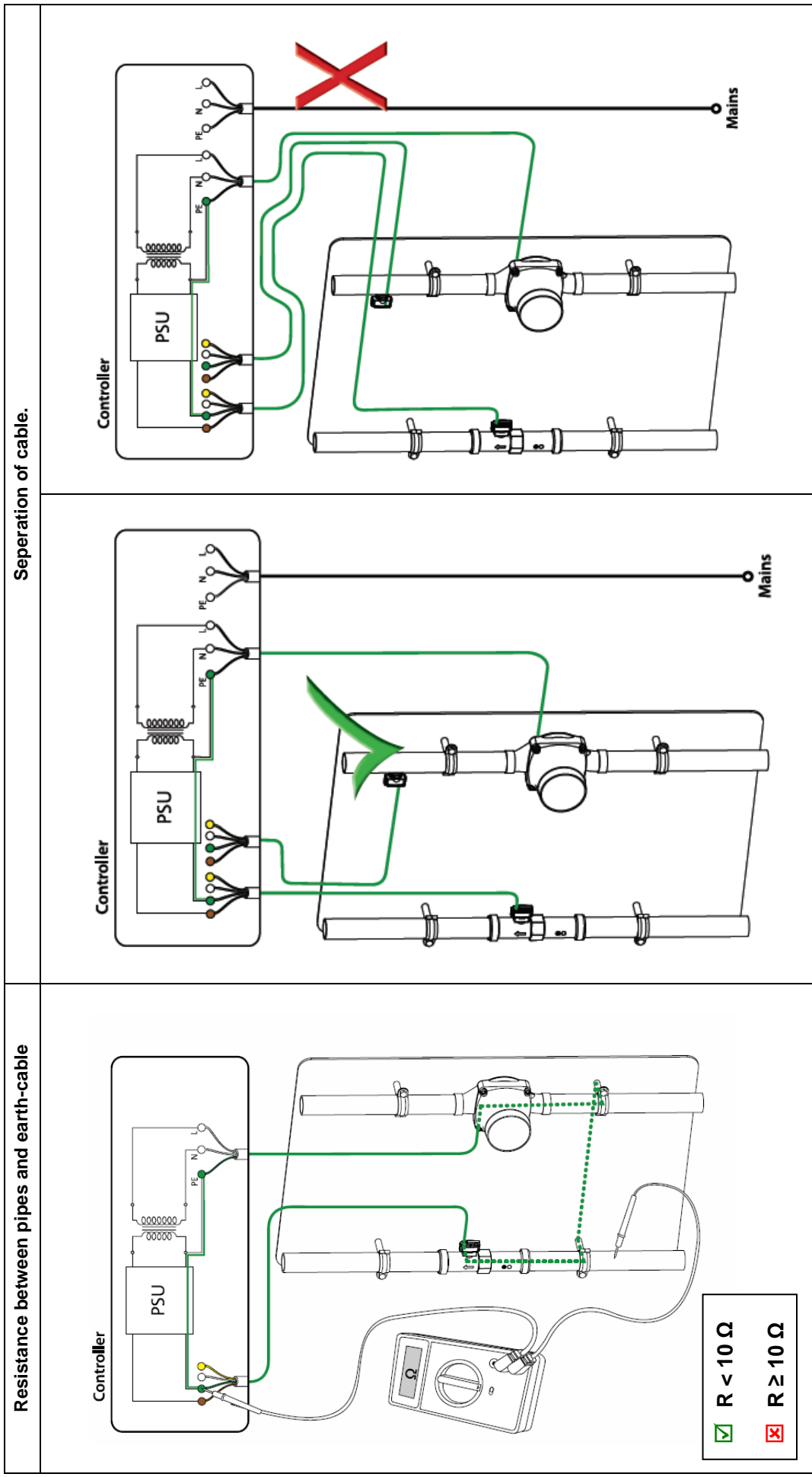

0311424 R0.0 EN





## IMPORTANT INFORMATION

These instructions must be read and understood before installing, commissioning, operating or maintaining the equipment.

